



Installation Manual

62-72 Chevrolet Vehicles

Compressor Upgrade Kit (POA & STV Models)





Congratulations...

You have just purchased the highest quality, best performing A/C system upgrade ever designed for your Classic Vehicle.

To obtain the high level of performance and dependability our systems are known for, please pay close attention to the following instructions. Our installation steps and procedures are derived from a long history of research and development and the combined experience achieved through thousands of successful installations (and feedback from customers like you). Please remember that our #1 goal is that you'll have a successful installation and a system that performs at a very high level for many years to come.

Before starting, read the instructions carefully, from beginning to end, and follow the proper sequence. On the next page you'll find a safety and general checklist that you should read before starting your installation.

Again, thank you from our entire staff.



PRE-INSTALLATION:

- Before beginning the installation, check the shipping box for the correct components.
- **If your vehicle has been or is being modified, some procedures will need to be adjusted to fit your particular application.**
- A basic cleaning of the engine compartment before beginning will make things go more smoothly.
- Check condition of engine mounts. Excessive engine movement can damage hoses to A/C and/or heater.
- **DISCONNECT THE BATTERY FIRST**
- **DISCHARGE THE SYSTEM NEXT;** You will want to have your system evacuated of all remaining refrigerant according to local laws. An A/C service shop can handle this for you.
- **TOOLS/MATERIALS REQUIRED:** A complete standard socket set, and standard wrench sets, (A set of standard ratcheting wrenches is suggested for the compressor installation), Magnet (Reach Tool), (2x) Medium Adjustable Wrenches, Flat Screwdriver, Wire cutter w/ crimper, and Tape or Caps.

PLEASE NOTE! IN ORDER TO PROTECT NEWLY INSTALLED PARTS, IT'S CRITICAL THAT THE CONDENSER, LIQUID LINE AND EVAPORATOR ARE CLEAN AND FREE OF CONTAMINATION. DAMAGE TO COMPONENTS AS A RESULT OF CONTAMINATION WILL NOT BE COVERED UNDER WARRANTY.

IMPORTANT NOTES:

- Use one or two drops of oil (supplied with your kit) on **ALL** O-rings, and threads.
- All capped fittings **MUST** remain covered until actual connection of the fitting to prevent contamination.
- Use two adjustable wrenches on all O-ring connections, these should be tightened to 10-15 ft/lbs which is hand tight plus ¼ turn. Over tightening could cause splitting of the O-ring.
- Carefully thread fittings. Fittings will thread easily, therefore if there is resistance, back off and re-align to avoid cross-threading. Be careful not to over tighten.

Should you have any technical questions, call us immediately, we will be glad to assist you.

Our toll-free number is listed on every page, we're here to help!

YOU CAN NOW BEGIN THE INSTALLATION...



THESE ARE THE PARTS FOR YOUR COMPRESSOR UPGRADE KIT

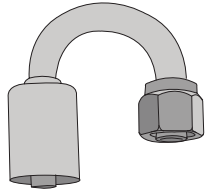

180 Degree Evaporator Fittings for Suction hose at STV or POA Valve
Typical fitting shown.
Some kits will include a different or custom fitting.

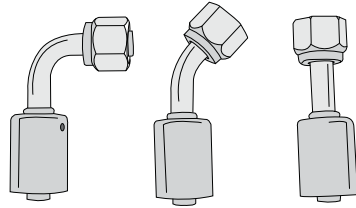

Condenser Discharge Fitting
(Only 1 will be included)
Some kits will include 1 custom fitting in lieu of the 3 shown or a clamp for earlier models

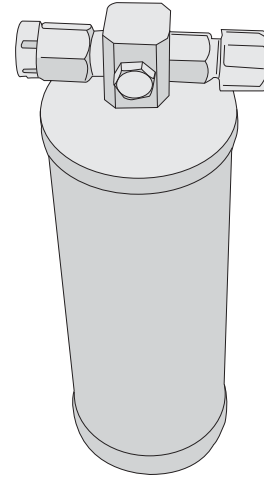

Model Specific Drier

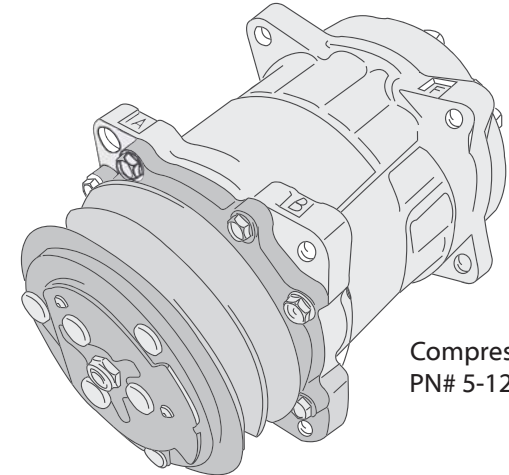

Compressor
PN# 5-128-5

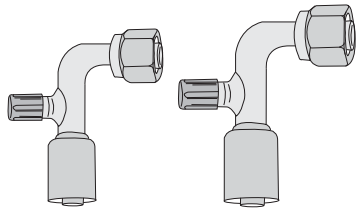

90 Degree Compressor Fittings w/ charge ports



Hose Clamp(s)
Only included for vehicles equipped with barbed fitting connections at either the condenser and/or evaporator

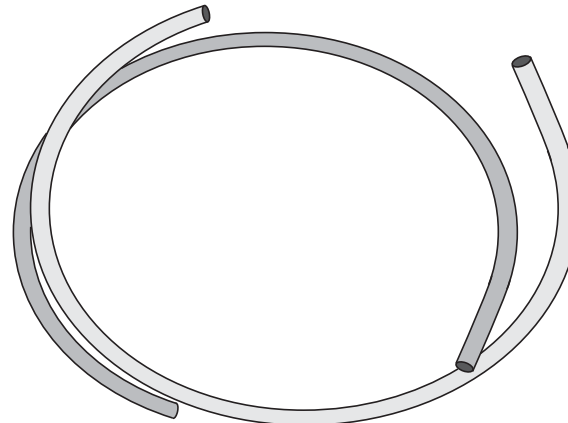

(1) #8 Discharge Hose *(one end open)*
(1) #10 Suction Hose *(one end open)*

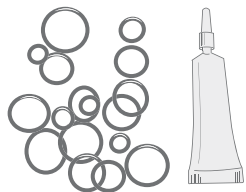

O-Rings and Lubricant Oil
PN# 05-400

Compressor Brackets

- SWP Small Block Bracket Kit # 06-205
- LWP Small Block Bracket Kit # 06-208
- SWP Big Block Bracket Kit # 06-212
- LWP Big Block Bracket Kit # 06-228

*Most common bracket kits listed.
Some applications may use alternate brackets kits*



DRIER REMOVAL

- Disconnect the liquid line, both solid tubing and hose from Drier.
- Loosen the Drier Bracket, Remove the drier and retain brackets for re-assembly

COMPRESSOR & HOSE REMOVAL

- Disconnect the magnetic clutch-to-control-unit wire
- Remove suction hose from STV or POA Valve at evaporator
- Disconnect the discharge hose from the condenser
- Disconnect and remove the hose assembly (from compressor)
- Loosen and remove compressor pulley belts
- Remove the compressor-to-bracket attaching bolts, and remove compressor
- Remove factory compressor brackets from engine

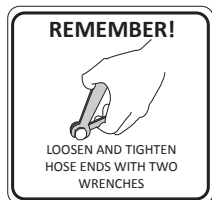

IMPORTANT - READ BEFORE PROCEEDING!

IN ORDER TO PROTECT NEWLY INSTALLED PARTS, IT'S CRITICAL THAT THE CONDENSER, LIQUID LINES AND EVAPORATOR ARE COMPLETELY CLEAN AND FREE OF CONTAMINATION. DAMAGE TO COMPONENTS AS A RESULT OF CONTAMINATION WILL NOT BE COVERED UNDER WARRANTY.

COMPRESSOR INSTALLATION

- **At this time refer to the engine-specific bracket instructions included with your kit, and install mounting bracket and compressor**

DRIER INSTALLATION

- Using your factory drier bracket, mount the included drier in the factory location with the "in" port facing toward the condenser
- Connect to the factory front liquid line coming from the condenser to the "in" port of the new drier
- Connect the factory rear liquid hose to the outlet of the drier



HOSE INSTALLATION

The hose set for your vehicle will include at least one fitting pre-crimped to each hose. After routing hoses, cut hose to length. Be sure to mark the orientation of the hose and fitting in order to have crimped with appropriate indexing.

- Connect the Suction hose fitting to the "S" inlet of the compressor and the discharge hose fitting to the "D" outlet of the compressor.
- Connect the Suction hose fitting to the POA or STV at the evaporator.
- Connect the Discharge hose end to the condenser,
- Route the hoses and cut to length. Be sure to mark the orientation of the hose and fitting in order to have crimped with appropriate indexing.

Classic Auto Air can provide crimping service on the hose fittings OR you can have a local A/C shop do this for you.

DO NOT USE HYDRAULIC CRIMPS ON A/C HOSES - THE CRIMP IS DIFFERENT AND WILL LEAK!

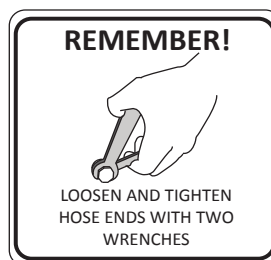

FINAL STEPS

Take a look around at your installation and check all fittings and bolts for tightness, and make sure nothing is routed in a way to obstruct any moving parts. You can reconnect the battery and re-install the belt at this time.

PLEASE NOTE! IN ORDER TO PROTECT NEWLY INSTALLED PARTS, IT'S CRITICAL THAT THE CONDENSER, LIQUID LINE AND EVAPORATOR ARE CLEAN AND FREE OF CONTAMINATION. DAMAGE TO COMPONENTS AS A RESULT OF CONTAMINATION WILL NOT BE COVERED UNDER WARRANTY.